

CF125 & CF125L

Dirt Bike

Owners Manual



* PLEASE READ THE MANUAL BEFORE OPERATION *
* FOLLOW OUR WARNINGS *

A Few Words About Safety

Your safety, and the safety of others, is very important. And operating this motorcycle safely is an important responsibility.

To help you make informed decisions about safety, we have provided operating procedures and other information on labels and in this manual. This information alerts you to potential hazards that could hurt you or others.

Of course, it is not practical or possible to warn you about all hazards associated with operating or maintaining a motorcycle. You must use your own good judgment.

You will find important safety information in a variety of forms, including:

- **Safety Labels** -- on the motorcycle.
- **Safety Messages** -- preceded by a safety alert symbol and one of three signal words: **DANGER, WARNING, or CAUTION.**

These signal words mean:

▲DANGER You **WILL** be **KILLED** or **SERIOUSLY HURT** if you don't follow instructions.

▲WARNING You **CAN** be **KILLED** or **SERIOUSLY HURT** if you don't follow instructions.

▲CAUTION You **CAN** be **HURT** if you don't follow instructions.

- **Safety Headings** -- such as **Important Safety Reminders** or **Important Safety Precautions.**
- **Safety Section** -- such as **Motorcycle Safety.**
- **Instructions**-- how to use this motorcycle correctly and safely.

This entire book is filled with important safety information -- please read it carefully.

These pages give an overview of the contents of your owner's manual. The first page of each section lists the topics covered in that section.

Introduction

Motorcycle Safety	1
Important safety information, a special message for parents, precautions about loading, accessories, and modifications, and the location of safety labels.	
Operating Controls	6
The location, function, and operation of the throttle, brakes, and other basic controls.	
Before Riding	8
The importance of wearing a helmet and other protective gear, plus how to make sure you and your motorcycle are ready to ride.	

Basic Operation & Riding..... 9

How to start and stop the engine, shift gears, and brake. Also, riding precautions.

Servicing Your Dirt Bike

Why your motorcycle needs regular maintenance, what you need to know before servicing your Dirt Bike, a maintenance schedule, and instructions for specific maintenance items.

Motorcycle Safety

This section presents some of the most important information and recommendations to help you ride your motorcycle safely. Please take a few moments to read these pages. This section also includes a special message for parents and location information for the safety labels on your motorcycle.

Your motorcycle can provide many years of service and pleasure--if you take responsibility for your own safety and understand the challenges you can meet while riding.

This motorcycle has been designed for younger riders. However, not all youngsters are physically or emotionally ready to ride. Therefore, before parents allow any youngster to ride this motorcycle, we urge them to carefully read the Important Message to Parents beginning and the Parents, Youngsters and Off-Highway Motorcycles booklet that came with the motorcycle.

There is much that you can do to protect yourself when you ride. You'll find many helpful recommendations throughout this manual. The following are a few that we consider most important.

Ride Off-Road Only

Your motorcycle is designed and manufactured for off-road use only. The tires are not made for pavement, and the motorcycle does not have turn signals and other features required for use on public roads. If you need to cross a paved or public road, get off and walk your motorcycle across.

Take Time to Learn and Practice

Developing off-road riding skills is a gradual, step-by-step process. Start by practicing at low speeds in a safe area and slowly build your skills. Personal instruction from an experienced rider can also be valuable.

If you need assistance, ask your dealer about riding groups in your area.

Also be sure to read the Tips & Practice Guide for the Off-Highway Motorcyclist booklet that came with your motorcycle (USA only).

Important Safety Information.....	2
Important Message to Parents.....	5
Loading, Accessories & Modifications.....	8
Loading.....	8
Accessories & Modifications.....	10
Safety Labels.....	12

Always Wear a Helmet

It's a proven fact: helmets significantly reduce the number and severity of head injuries. So always wear an approved motorcycle helmet. We also recommend that you wear eye protection, sturdy boots, gloves, and other protective gear.

Never Carry a Passenger

Your motorcycle is designed for one person only. There are no handholds, footrests, or seat for a second person--so never carry a passenger. A passenger could interfere with your ability to move around to maintain your balance and control of the motorcycle.

Be Alert for Off-Road Hazards

The terrain can present a variety of challenges when you ride off-road. Continually "read" the terrain, for unexpected turns, drop-offs, rocks, ruts, and other hazards. Always keep your speed low enough to allow time to see and react to hazards.

Ride within Your Limits

Pushing limits is another major cause of motorcycle accidents. Never ride beyond your personal abilities or faster than conditions warrant. Remember that alcohol, drugs, fatigue, and inattention can significantly reduce your ability to make good judgments and ride safely.

Important Safety Information

Don't Drink and Ride

Alcohol and riding don't mix. Even one drink can reduce your ability to respond to changing conditions, and your reaction time gets worse with every additional drink. So don't drink and ride, and don't let your friends drink and ride either.

Keep Your Dirt Bike in Safe Condition

It's important to keep your motorcycle properly maintained and in safe riding condition. Having a breakdown can be difficult, especially if you are stranded off-road far from your base. To help avoid problems, inspect your motorcycle before every ride and perform all recommended maintenance.

That's why we urge you to read this message before you let any young person ride this motorcycle. Off-road riding can be fun. But, as with riding a bicycle, bad judgment can result in injury, and we don't want that to happen! As a parent, you can help prevent accidents by making good decisions about if, when, and how your youngster rides this motorcycle.

Riding Readiness

The first decision you'll need to make is whether your youngster is ready to ride. Riding readiness varies widely from one person to another, and age and size are not the only factors.

Instruction and Supervision

If you decide that your youngster is ready to safely operate this motorcycle, make sure both of you carefully read and understand the owner's manual before riding. Also be sure that your youngster has a helmet and other appropriate riding equipment and always wears it when operating the vehicle or sitting it.

consideration. For example, riders must be big enough to hold the motorcycle up, get on, and comfortably sit on the seat with both feet touching the ground. They should also be able to easily reach and work the brakes, throttle, and all other controls.

ATHLETIC ABILITY is necessary for riding a motorcycle. Generally speaking, your youngster should be good at riding a bicycle before getting on a motorcycle. Can your youngster judge speeds and distances while riding a bicycle and react with proper hand and foot actions? Anyone who does not have good coordination, balance, and agility is not ready to ride this motorcycle.

youngster's safety. Remember, learning to ride a motorcycle is a gradual, step-by-step process. It takes time, patience, and practice--many hours over a period of weeks or months.

To help your youngster build confidence as they're learning to ride, this bike was delivered with a speed restrictor that limits top speed. We recommend that all beginning riders start off with the speed restrictor may be adjusted to gradually increase maximum speed as the beginner becomes more familiar with riding their bikemotorcycle. For adjustment and removal instructions, see page 71.

Important Message to Parents

SUPERVISION is another important obligation of parents. Even after youngsters have become skilled off-road riders, they should always ride with adult supervision. It helps to regularly remind young riders of basic safety rules and precautions. And remember, it's your responsibility to see that the motorcycle is properly maintained and kept in safe operating condition.

SAFE AND RESPONSIBLE RIDING must be an on-going commitment--by you and your youngster. When you both put safety first, you can enjoy more peace of mind, and your youngster can enjoy more hours of safe off-road riding.

For your convenience, this DIRT BIKE comes with an ignition switch and key. Remove the key when the motorcycle is parked to help prevent unauthorized use.

Your Dirt Bike was designed as a rider-only motorcycle. It was not designed to carry a passenger or cargo. A passenger or cargo could interfere with your ability to move around to maintain your balance and control of the motorcycle.

In addition, exceeding the weight limits or carrying an unbalanced load can seriously affect your motorcycle's handling, braking, and stability. Adding accessories or making modifications that change this motorcycle's design and performance can also make it unsafe. Also, the weight of any accessories will reduce the maximum load the motorcycle can carry.

Load Limits

Following are the load limits for your motorcycle:

Maximum weight capacity
= 88 lbs (150kg)

Includes the weight of the rider and any accessories.

Loading Guidelines

As discussed on page 8, we recommend that you do not carry any cargo on this motorcycle. However, if you decide to carry cargo, ride at reduced speeds and follow these common-sense guidelines:

Keep cargo small and light. Make sure it cannot easily be caught on brush or other objects, and that it does not interfere with your ability to shift position to maintain balance and stability.

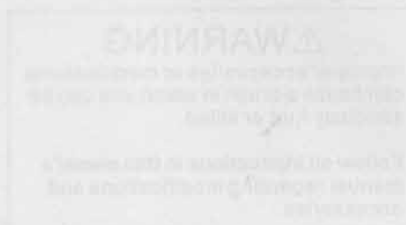

More specific information on load limits, accessories, and modifications follows.

Loading

How much weight you put on your motorcycle, and how you load it, are important to your safety. If you decide to carry cargo, you should be aware of the following information.

⚠ WARNING

Overloading or carrying a passenger can cause a crash and you can be seriously hurt or killed.

Follow all load limits and other loading guidelines in this manual.

- Place weight as close to the center of the motorcycle as possible.
- Do not attach large or heavy items (such as a sleeping bag or tent) to the handlebar, fork, or front fender.
- Make sure that all cargo is tied down securely.
- Never exceed the maximum weight limit.
- Check that both tires are inflated properly.

Accessories & Modifications

Modifying your motorcycle or using non-Best accessories can keep on your motorcycle unsafe.

Before you consider making any modifications or adding an accessory, be sure to read the following information.

⚠ WARNING

Improper accessories or modifications can cause a crash in which you can be seriously hurt or killed.

Follow all instructions in this owner's manual regarding modifications and accessories.

Modifications

We strongly advise you not to remove any original equipment or modify your motorcycle in any way that would change its design or operation. Such changes could seriously impair your motorcycle's handling, stability, and braking, making it unsafe to ride.

We also advise you not to make any modifications or remove any equipment (such as the USDA qualified spark arrester or emission control system components) that would make the motorcycle illegal in your area.

Accessories

Check with your dealer for assistance and always follow this guideline:

- Make sure the accessory does not reduce ground clearance and lean angle, limit suspension travel or steering travel, alter your riding position, or interfere with operating any controls.

This page shows the locations of safety labels on your motorcycle. Some labels warn you of potential hazards that could cause serious injury. Others provide important safety information. Read these labels carefully and don't remove them.

If a label comes off or becomes hard to read, contact your Dirt Bike dealer for a replacement.

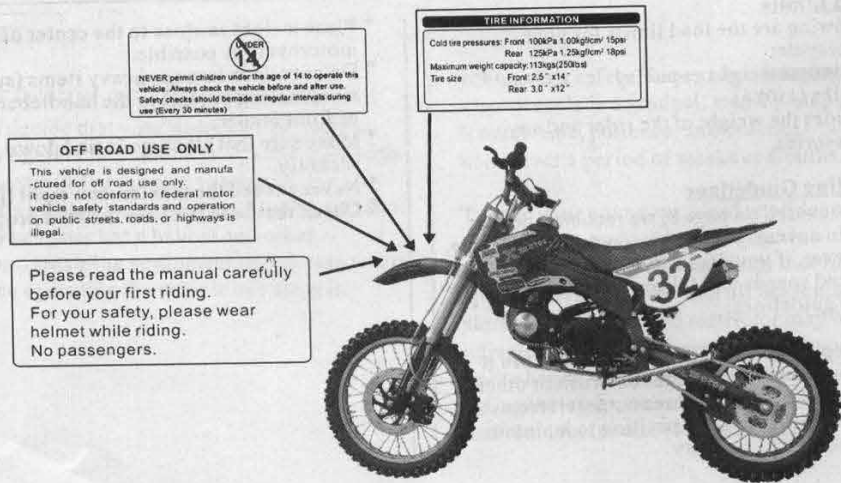

Operating Controls

When you ride off-road, you need to operate the throttle, brakes, and other controls without stopping to look at them. Read this section carefully before you ride. It describes the location, function, and operation of all the basic controls on your motorcycle.

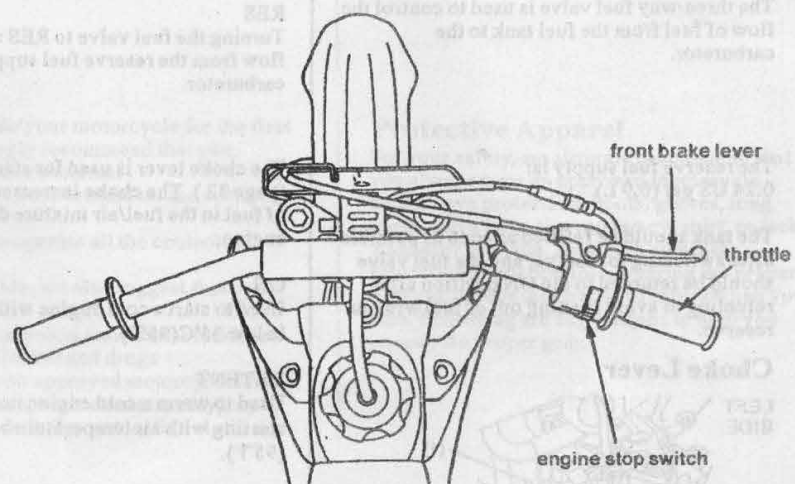
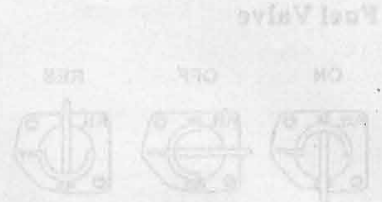

Component Locations

Fuel Valve

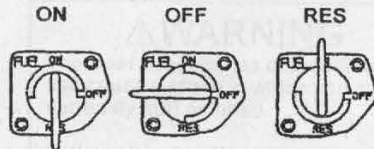

The three-way fuel valve is used to control the flow of fuel from the fuel tank to the carburetor.

The reserve fuel supply is:
0.24 US gal (0.9 L)

The tank should be refilled as soon as possible after switching to reserve, and the fuel valve should be returned to the ON position after refueling to avoid running out of fuel with no reserve.

Choke Lever

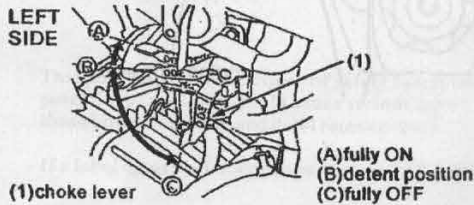

ON

Turning the fuel valve ON before attempting to start the engine allows fuel to flow from the fuel tank to the carburetor.

OFF

Turning the fuel valve OFF after stopping the engine prevents the flow of fuel from the fuel tank to the carburetor.

RES

Turning the fuel valve to RES allows fuel to flow from the reserve fuel supply to the carburetor.

The choke lever is used for starting the engine (page 32). The choke increases the percentage of fuel in the fuel/air mixture delivered to the engine.

ON

Used to start a cold engine with air temperature below 35°C(95°F).

DETENT

Used to warm a cold engine immediately after starting with air temperature below 35°C (95°F).

OFF

Used for normal operation, for restarting a warm engine, or starting a cold engine with air temperature above 35°C(95°F).

Before Riding

Before each ride, you need to make sure you and your Dirt Bike are both ready to ride. To help get you prepared, this section discusses how to evaluate your riding readiness, and how to perform the recommended pre-ride inspection of your Dirt Bike. If you're a parent, be sure you also read the Important Message to Parents.

Before you ride your motorcycle for the first time, we strongly recommend that you:

- read this owner's manual
- make sure you understand all the safety messages
- know how to operate all the controls

Before each ride, we also suggest that you make sure you:

- are in good physical and mental condition
- are free of alcohol and drugs
- are wearing an approved motorcycle helmet (with chin strap tightened securely), eye protection, and other protective clothing

⚠ WARNING

Not wearing a helmet increases the chance of serious injury or death in a crash.

Be sure you always wear a helmet, eye protection and other protective apparel when you ride.

Helmets and Eye Protection

Your helmet is your important piece of riding gear because it offers the best protection against head injuries. A helmet should fit your head comfortably and have a chin strap that can be tightened securely.

Key Position	Function	Key Removal
OFF	The engine cannot be operated.	The key can be removed.
ON	With the engine stop switch at RUN and the transmission in neutral, the engine can be started.	The key cannot be removed.

Protective Apparel

For your safety, we strongly recommend that you always wear an approved motorcycle helmet, eye protection, boots, gloves, long pants, and a long-sleeved jersey, shirt, or jacket whenever you ride. Although complete protection is not possible, wearing the proper gear can reduce the chance of injury when you ride. Following are suggestions to help you choose the proper gear.

Always wear a face shield or goggles to protect your eyes and help your vision.

Additional Riding Gear

In addition to a helmet and eye protection, we also recommend:

- Sturdy off-road motorcycle boots to help protect your feet, ankles, and lower legs.
- Off-road motorcycle gloves to help protect your hands.
- Riding pants with knee and hip pads, a riding jersey with padded elbows, and a chest/shoulder protector.

Operating Controls

Ignition Switch

The ignition switch is used to prevent unauthorized use of the motorcycle.

Before riding, insert the key and turn it to the right for the ON position.

Key Position	Function	Key Removal
OFF	The engine cannot be operated.	The key can be removed.
ON	With the engine stop switch at RUN and the transmission in neutral, the engine can be started.	The key cannot be removed.

After parking the motorcycle, remove the key.

Engine Stop Switch

The engine stop switch is used to turn the engine off during normal riding situations. To operate, turn the switch to either OFF position. The switch must be in the RUN position to start the engine.

Front Brake Lever

The front brake lever is used to slow or stop your motorcycle. To operate, pull the lever. For information on braking techniques.

Shift Lever

The shift lever is used to select the next higher or lower gear in the transmission. To operate, raise the shift lever (after closing the throttle) to engage the next higher gear or depress the shift lever to engage the next lower gear.

Rear Brake Pedal

The rear brake pedal is used to slow or stop your motorcycle. To operate, depress the pedal. For information on braking techniques.

RIGHT SIDE (under fuel tank)

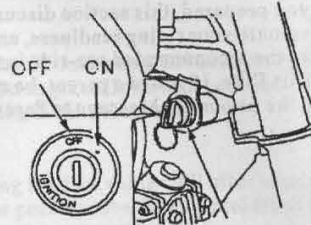

(1) ignition switch

(1)

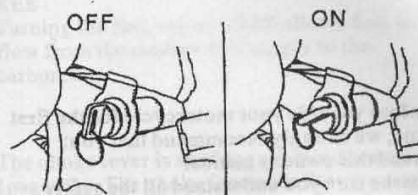

Throttle

The throttle controls engine rpm (speed). To increase engine rpm, rotate the grip toward you. To reduce engine rpm, rotate the grip away from you. The throttle will automatically return to the closed position (engine idle) when you remove your hand.

Kickstarter

The kickstarter is used to start the engine. To operate, swing the kickstarter out from its stored position and depress it through its entire stroke.

Side Stand

The side stand is used to support your motorcycle while parked. To operate, use your foot to lower the stand. Before riding, raise the stand.

Is Your Motorcycle Ready to Ride?

Before each ride, it's important to inspect your motorcycle and make sure any problem you find is corrected. A pre-ride inspection is a must because off-road riding can be tough on a motorcycle and you don't want to have a breakdown far from help.

WARNING

Improperly maintaining this motorcycle or failing to correct a problem before riding can cause a crash in which you can be seriously hurt or killed.

Always perform a pre-ride inspection before every ride and correct any problems.

Pre-ride Inspection

Check the following items before you get on the motorcycle:

- Tires** Use a gauge to check the air pressure. Adjust if needed. Also look for signs of damage or excessive wear.
- Spokes & Rims** Make sure the spokes are tight. Also check the rims for damage.
- Leaks** Look under the motorcycle for signs of leaking fluids (fuel, engine oil).
- Engine Oil** Check the level and add oil if needed.

Check these items after you get on the motorcycle:

- Throttle** Check the freeplay and adjust if needed. Rotate the throttle to make sure it moves smoothly without sticking, and snaps shut automatically when it is released, in all steering positions.
- Brake** Squeeze the front brake lever and step on the rear brake pedal to check that the controls operate normally. Adjust freeplay, if necessary.

Note to Parents:

If a youngster will be performing any of the following pre-ride inspection procedures, it's your responsibility to provide careful supervision and make sure they are performed safely.

- Fuel** Check the level and add fuel if needed. Also make sure the fuel fill cap is securely fastened.
- Drive Chain** Check the condition and slack. Adjust and lubricate if needed. Also check the chain slider for wear and replace if needed.
- Cables** Check the cable housings for wear. Check the fittings for looseness. Replace or tighten as needed.
- Nuts & Bolts** Use a wrench to make sure all accessible nuts, bolts, and fasteners are tight.
- Spark Plug & Cap** Check for looseness.

Remember, be sure to take care of any problem you find or have your Dirt Bike dealer correct it before you ride.

Component Locations

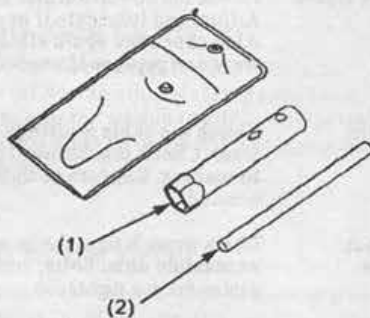

(1) spark plug wrench
(2) handle

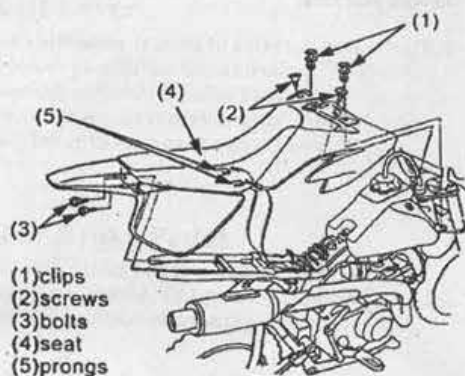

(1) clips
(2) screws
(3) bolts
(4) seat
(5) prongs

The spark plug wrench (1) and its handle (2) are stored in the tool bag delivered with your motorcycle.

You will need to provide your own tools to perform any owner maintenance other than removing the spark plug.

Removal

1. Remove the clips (1) and screws (2) on the fuel tank shroud.
2. Remove the bolts (3) under the rear fender.
3. Slide the seat (4) with fuel tank shroud and rear cowl back.

Installation

1. Position the prongs (5) under the seat into the spaces for them in the frame.
2. Install the bolts and screws and tighten them, then install the clips.

Maintenance Safety

The maintenance section includes instructions on how to perform some important maintenance tasks. Some of the most important safety precautions follow. However, we cannot warn you of every conceivable hazard that can arise in performing maintenance. Only you can decide whether or not you should perform a given task.

⚠ WARNING

Failure to properly follow maintenance instructions and precautions can cause you to be seriously hurt or killed.

Always follow the procedures and precautions in this owner's manual.

- Read the instructions, before you begin, and make sure you have the tools and skills required.

To help prevent the motorcycle from falling over, park it on a firm, level surface, using the side stand or a maintenance stand to provide support.

To reduce the possibility of a fire or explosion, be careful when working around gasoline. Use only a non-flammable (high flash point) solvent such as kerosene--not gasoline--to clean parts. Keep cigarettes, sparks, and flames away from all fuel-related parts.

Important Safety Precautions

Make sure the engine is off before you begin any maintenance or repairs.

This will help eliminate several potential hazards:

Carbon monoxide poisoning from engine exhaust. Be sure there is adequate ventilation whenever you operate the engine.

Burns from hot motorcycle parts. Let the engine and exhaust system cool before touching.

Injury from moving parts. Do not run the engine unless instructed to do so.



Throttle

Throttle Freeplay

RIGHT SIDE

(1) freeplay

(2) dust cover
(3) lock nut
(4) adjuster

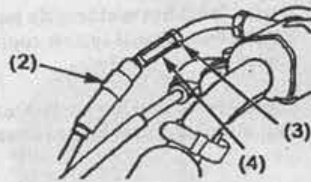
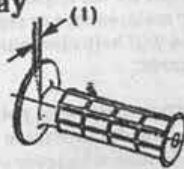

Throttle Freeplay



(1) throttle
(2) throttle cable

1. Check that the throttle assembly is positioned properly and the securing bolts are tight.

Throttle Freeplay

RIGHT HANDLEBAR

(1) lock nut
(2) throttle limiter screw
(3) throttle limiter screw measurement

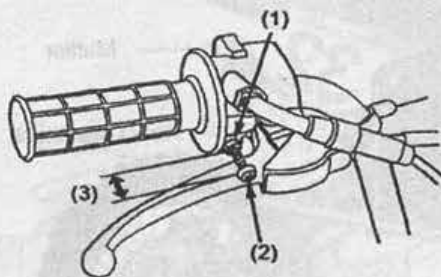

Inspection

Check freeplay (1).

Freeplay: 1/16–3/16 in (2.0–4.0 mm)

If necessary, adjust to the specified range.

Adjustment

1. Pull the rubber dust cover (2) back.
2. Loosen the lock nut (3) on the throttle cable mechanism.
3. Turn the adjuster (4).
4. Tighten the lock nut. Return the dust cover to its normal position.
5. After adjustment, check for smooth rotation of the throttle grip from fully closed to fully open in all steering positions.

If you can't get the freeplay within the specified range, contact your Dirt Bike dealer.

2. Check for smooth rotation of the throttle (1) from fully open to fully closed in all steering positions. If there is a problem, see your Dirt Bike dealer.
3. Inspect the condition of the throttle cable (2) from the throttle grip down to the carburetor. If the cable is kinked or chafed, have it replaced.
4. Check the cable for tension or stress in all steering positions.
5. Lubricate the cable with a commercially-available cable lubricant to prevent premature rust and corrosion.

1. Loosen the lock nut (1).
2. Turn the throttle limiter screw (2) clockwise to reduce throttle grip movement or counterclockwise to increase throttle grip movement.

The throttle limiter screw measurement (3) is 13/16 in (21 mm) when the throttle is fully open; less than 13/16 in (21 mm) when the throttle opening (and maximum engine speed) is restricted.

3. Hold the screw in place and tighten the lock nut.

To prevent moisture or debris (dirt, sand, pebbles, sticks, etc.) from entering the throttle housing, do not remove the throttle limiter screw. Moisture and debris may interfere with proper throttle operation.

Clutch System

Inspection

the engine should start easily with the kicks tarter without the clutch slipping. When shifting gears, the clutch operation should be smooth and light, especially when shifting into neutral.

Adjustment

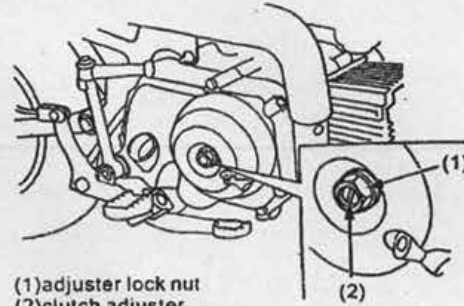

(1)adjuster lock nut
(2)clutch adjuster

1. Loosen the adjuster lock nut (1).
2. Turn the clutch adjuster (2) clockwise one turn; do not turn excessively.

3. Slowly turn the adjuster counterclockwise until a slight resistance is felt.
4. From this position, turn the adjuster clockwise 1/8 to 1/4 turn, and tighten the lock nut.
5. After adjustment, test ride the motorcycle to be certain the clutch operates properly.

If you can't get proper adjustment, or the clutch does not work properly, see your Dirt Bike dealer.

Excessive valve clearance will cause noise and eventual engine damage. Little or no clearance will prevent the valve from closing and cause valve damage and power loss. Check valve clearance when the engine is cold at the intervals specified in the Maintenance Schedule.

The checking or adjusting of the clearance should be performed while the engine is cold. The clearance will change as engine temperature rises.

LEFT SIDE

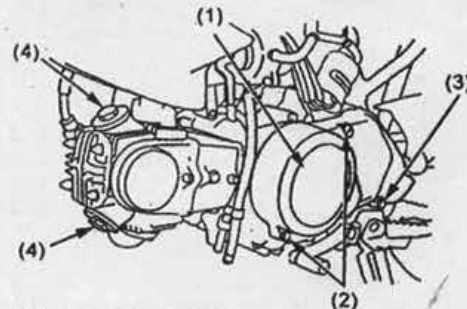

(1)left crankcase cover
(2)bolts A
(3)bolt B
(4)adjusting hole caps

1. Remove the left crankcase cover (1) by removing the bolts A (2) and bolt B (3).
2. Remove the adjusting hole caps (4).